

1. Summary

Caution: includes asbestos sheet with drilled holes.

S.N. 272

Operating manual: <https://bama.edebris.com/manuals/gr/783a/>

Impedance Setting:

Multiplier: 0.1, 1, 10, 100

Ohms: 25, 30, 40, 50, 60, 80, 100, 125, 150, 200

Impedance span in 4 decades from 2.5Ω to $20k\Omega$, with 2.5, 3, 4, 5, 6, 8, 10, 12.5, 15, 20 steps. Frequency range 20Hz to 15kHz. Power meter range from 0.2mW to 100W (+/-0.75dB): -10dB to +50dB re 1mW. All impedance values and measurement ranges are accurate for DC resistance measurement when Power Multiplier is in 1W, and 10W settings. When power multiplier is in 1mW, 10mW, 0.1W range then DC resistance measurement is modified.

All resistors IRC. 4uF 600VDC Cornell Dubilier. 100W at $20k\Omega$ requires 1.4kV. 100W at $2k\Omega$ = 450V.

Start with x10W power meter pushbutton setting. Tighten banana connector screws when plugging in a banana connector, as the plug only mates with the screw, not the socket base.

Asbestos board and possibly asbestos type high-temp wiring. Asbestos board painted with VHT calliper high temp black paint to immobilise any fibres.

2. Measurements

C1 4uF measures 6.8uF but jiggles, and its leakage with an IR meter is low. A 4.4uF 63Vdc MKC4 cap was retro-fitted.

Impedance response to 90kHz indicates that the individual resistor segments for particularly the 0.1x multiplier range show significant inductive impedance and phase increase with frequency above 1-10kHz. The 1x range shows it to a lesser extent, and impedance change of the higher ranges appear to be negligible.

The individual resistor elements in the 0.1x and 1x ranges are not readily accessible – the related rotary switch wafers are innermost, and the resistor elements themselves are buried in the upper resistor chamber. This rules out adding RC compensation to each individual element, which would require about 20 added RC's.

A practical option is to use a banana plug interface to the main load terminals, with an RC compensation network connected in parallel with the loadbank. A different RC network/plug would be needed for each loadbank setting, although this could be minimised to just the 8R, 10R, 12.5R, 15R, and 20R as the most commonly used load settings. For 15R, the RC requires 150nF + 15R for a 71kHz corner, and impedance magnitude peaks at 15.5R before falling to 14.5 at circa 90kHz and then likely rising, and phase is flat but dips to -3 deg at 50-60kHz before increasing. In general, this form of compensation at the output terminals should be acceptable.

Amp testing with GR showed no change to waveform with/without compensation network. Power meter indication performance:

GR meter W	Power Mult	Vrms	Calc watt	Note
1	x1W	3.85	0.99	
5	x1W	7.70	3.95	
10	x1W	10.54	7.4	
1	x10W	12.37	10.2	
2	x10W	16.55	18.3	
3	x10W	19.27	24.8	Gross clip

15 Ω load setting. PA1003 amp with 770Hz sinewave output. Keithley 197 voltmeter.

Internal resistance values.

Multiplier S1	0.1	1	10	100
Ohms S2		20.818	208.18	2083.8
25	2.621	5.392	53.92	539.2
30	0.557	5.57	57.7	557
40	1.152	11.52	115.2	1152
50	1.21	12.1	121	1210
60	1.278	12.78	127.8	1278
80	2	20	200	2000
100	2	20	200	2000
125	2.5	25	250	2500
15-	2.5	25	250	2500
20-	5	50	500	5000
Series sum:	20.818	208.18	2083.8	20820

Calibration Dec 2021. Kiethley 197 with leads shorted and REL to show 0.00 ohm. Power multiplier pushbutton on 10W. In summary, all measured resistances were within 1%.

S1	0.1	1	10	100
25	2.50	24.93	250.6	2.515k
30	3.00	29.94	302.0	3.016k
40	4.00	39.93	402.0	4.018k
50	4.99	50.00	503.0	5.020k
60	5.99	60.08	602.5	6.02k
80	7.95	80.3	803.0	8.04k
100	9.94	100.3	1004.5	10.06k
125	12.45	125.4	1255.5	12.58k
150	14.96	150.5	1506.0	15.09k
200	20.00	200.4	2015.0	20.15k

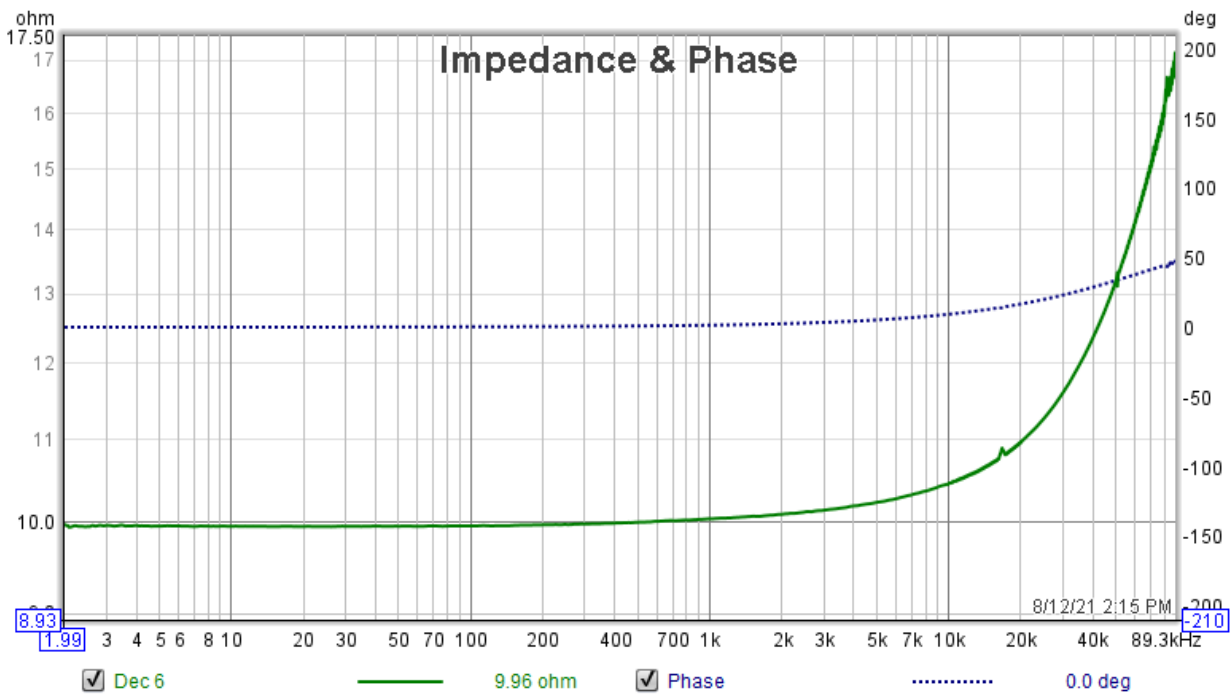

Impedance of 100Ω x 0.1 setting (ie. 10Ω) showing influence of resistor inductance.

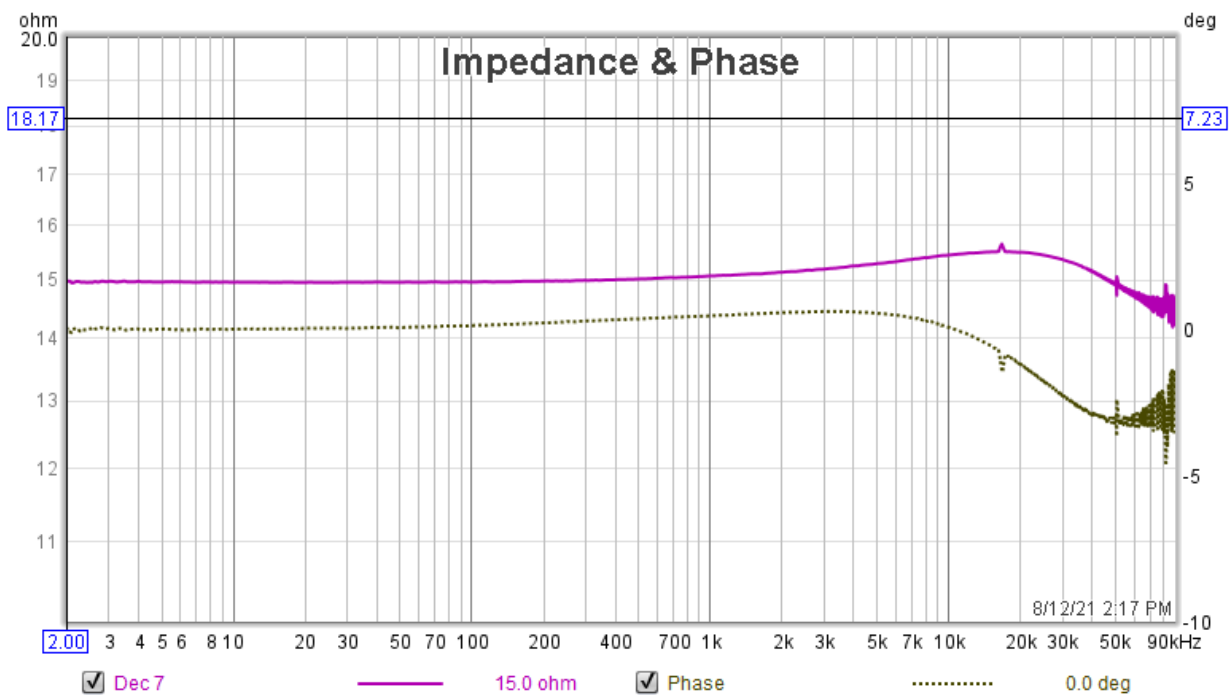

Impedance of 150Ω x 0.1 setting (ie. 15Ω) with simple 15Ω+150nF RC compensation network inserted at instrument terminals.

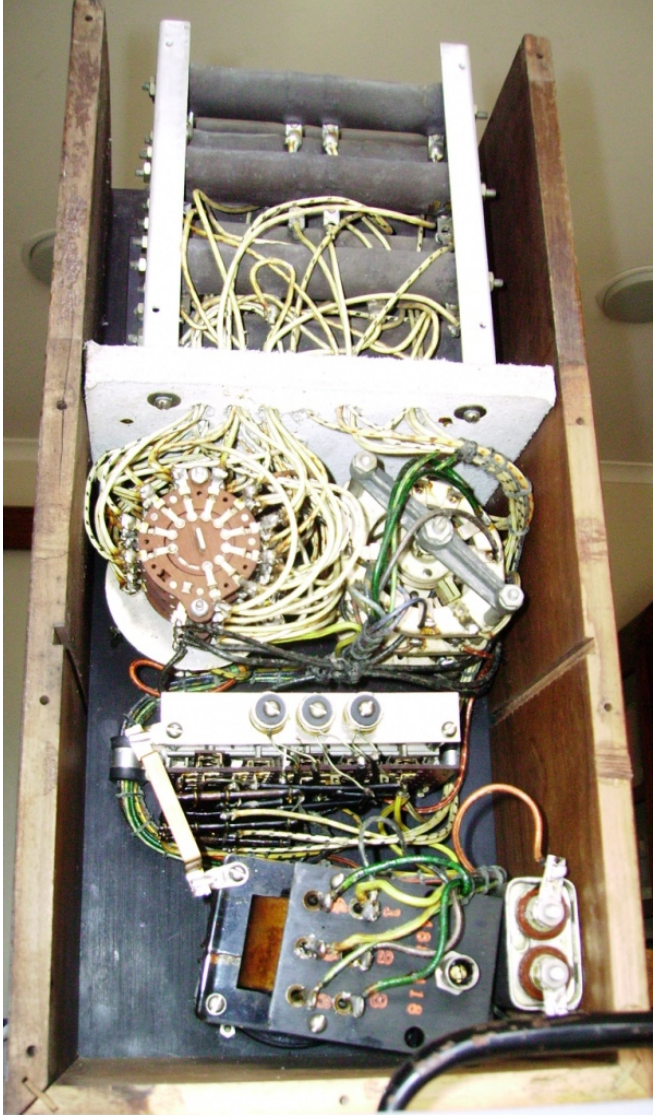

A 100-WATT OUTPUT POWER METER

● THE OUTPUT POWER METER for power-output and internal-impedance measurements on radio receivers, amplifiers, and oscillators was first introduced by General Radio nearly ten years ago.* Over a thousand of these instruments have been sold and, with the development of the art, their general utility around the communications laboratory is constantly increasing.

*"A Power Meter with a Wide Frequency Range," *Experimenter*, May, 1932. "A Direct-Reading Meter for Power and Impedance Measurements," *Experimenter*, November, 1932.

FIGURE 1. Panel view of the TYPE 783-A Output Power Meter.



It has been evident recently that there exists a field for an instrument of the same type but capable of dissipating greater amounts of power, and the new TYPE 783-A Output Power Meter has been designed to meet this need.

Nearly as sensitive at low power levels as the older TYPE 583, this new instrument has a much wider power range extending to a maximum of 100 watts. The power scale on the indicating meter extends from 0 to 10, and is used in conjunction with a set of five push-button-operated decade multipliers. An auxiliary decibel scale is provided on the meter, extending from -10 db to $+10$ db, referred to a level of 1 milliwatt.

The impedance range is 2.5 ohms to 20,000 ohms, covered by means of two switches, one direct reading in ohms, the other a multiplier.

The accuracies of both power and impedance indications are maintained over a considerably wider frequency range than in the TYPE 583.

A functional schematic diagram of the TYPE 783-A Output Power Meter is given in Figure 2. As can be seen from this diagram, the instrument is equivalent to an adjustable load impedance, across which is connected a voltmeter calibrated directly in watts dissipated in the load. It consists essentially of a voltage divider and an autotransformer for adjusting the impedance level, and a set of resistive pads for adjusting attenuation.

The operation of the output power meter is extremely simple. For measuring the power that a circuit is capable of delivering into a given impedance, the impedance switch and multiplier are set to the desired value, and the power is then indicated by the meter and its

multiplier. The internal impedance of the source under test can also be determined since it is equal to the impedance into which maximum power is delivered.

The output power meter is extremely useful in experimental work where a number of power and impedance measurements must be made as the characteristics of the circuit under measurement are varied. It is a valuable aid in the design and testing of amplifiers, oscillators, filters, transformers, and other networks, in making standard tests on radio receivers, and in measuring the power output of vacuum tubes. Its impedance range is wide enough to simu-

late all types of loudspeakers, and its sensitivity is sufficient to measure directly the output and internal impedance of a magnetic phonograph pickup.

Another use is in the measurement of the loss in a transformer working out of a given source impedance. The maximum output of the source is determined, after which the transformer is interposed between the source and the meter, and the maximum output of the transformer is found. The difference between the two readings on the decibel scale gives the transformer loss directly.

SPECIFICATIONS

Power Range: 0.2 milliwatt to 100 watts in five ranges (10 and 100 milliwatts, 1, 10, and 100 watts, full scale). An auxiliary decibel scale reads from -10 to $+50$ db referred to a level of 1 milliwatt.

Impedance Range: 2.5 to 20,000 ohms. Forty discrete impedances, distributed approximately logarithmically, are obtained by means of a ten-step OHMS dial and a four-step MULTIPLIER.

Impedance Accuracy: The input impedance is within $\pm 2\%$ of the indicated value, except at the higher audio frequencies, where the error for the higher impedance settings may exceed this value. At 15,000 cycles the input impedance error is about 5% for impedances from 10,000 to 20,000 ohms.

Power Accuracy: The indicated power is accurate to ± 0.25 db at full-scale reading. At the lowest impedance multiplier setting (2.5 to 20 ohms) there may be an additional error of 0.2 db due to switch contact resistance when the power multiplier is set at 10 (10 to 100 watt range).

The over-all frequency characteristic of the power indication is flat within ± 0.5 db from 20 cycles to 10,000 cycles; within ± 0.75 db to 15,000 cycles.

Waveform Error: The indicating instrument used is a copper-oxide rectifier meter, calibrated in r-m-s values for a sinusoidal applied voltage. When non-sinusoidal voltages are applied an error in indication may occur, since the meter is not a true r-m-s indicating device. The error

FIGURE 2. Schematic circuit diagram of the TYPE 783-A Output Power Meter.

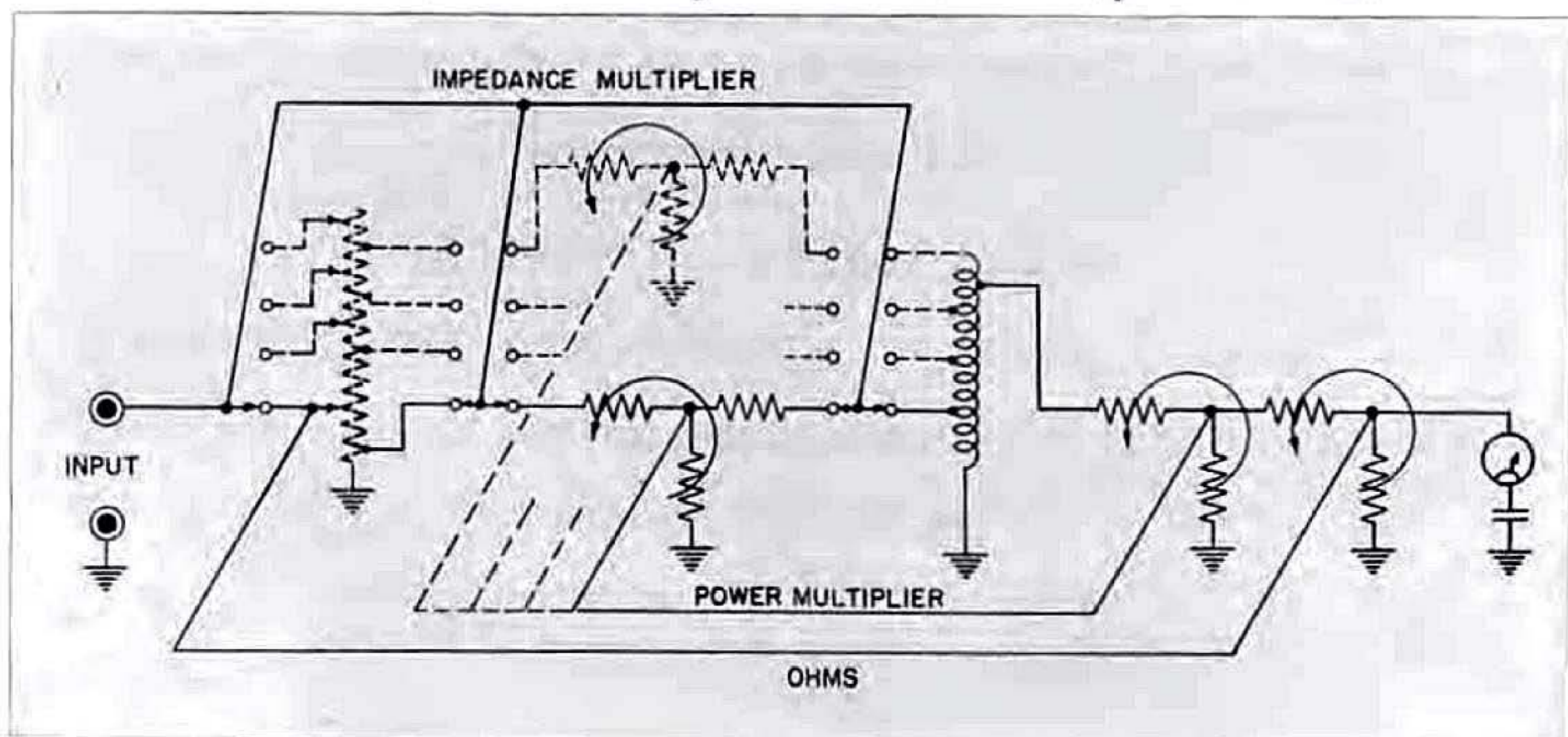

will depend on the magnitude and phase of the harmonics present, but, with waveforms normally encountered in measurement circuits at communications frequencies, will not be serious.

Temperature and Humidity Effects: Humidity conditions have a negligible effect on the accuracy of the instrument.

The instrument is calibrated at 77° Fahrenheit, and if the ambient temperature departs widely from this value, additional errors

of indication may be expected. At high temperatures (95° Fahrenheit) this additional error may approach the nominal calibration error, particularly at the higher frequencies.

The heat dissipated by the instrument itself has no effect on the accuracy.

Accessories Supplied: One TYPE 274-M Plug.

Mounting: The instrument is mounted on a bakelite panel in a walnut cabinet.

Dimensions: 8 x 18 x 7 inches, over-all.

Net Weight: 17 pounds.

<i>Type</i>	<i>Code Word</i>	<i>Price</i>
783-A Output-Power Meter	ABBEY	\$185.00

This instrument is manufactured and sold under United States Patents Nos. 1,901,343 and 1,901,344.

A-F OUTPUT POWER MEASUREMENTS

from 0.2 mw to 100 Watts

THIS direct-reading meter is invaluable for measurements of the power output of audio-frequency circuits. Essentially it is equivalent to an adjustable load impedance across which is connected a voltmeter calibrated directly in watts dissipated in the load. Its features include:

VERY WIDE RANGES

POWER: 0.2 milliwatt to 100 watts, in 5 ranges

IMPEDANCE: 2.5 to 20,000 ohms

GOOD ACCURACIES

IMPEDANCE: Within $\pm 2\%$, except at higher audio frequencies where error for higher impedance settings may be greater. At 15,000 cycles, input impedance error is about 5% for impedances from 10,000 to 20,000 ohms

POWER: Over-all frequency characteristic of power indication is flat within ± 0.5 db from 20 to 10,000 cycles; within ± 0.75 db to 15,000 cycles

WAVEFORM ERROR: A copper-oxide rectifier meter is used, calibrated in r-m-s values for sinusoidal applied voltage. When non-sinusoidal voltages are used, error in indication can occur. Error will depend upon magnitude and phase of harmonics present; it will not be serious with waveforms normally encountered in communication-frequency circuits

For testing amplifiers, transformers, telephone lines and other networks, the Type 783-A meter is a very handy, useful and accurate instrument. Considerable overloads, for a short time, can be handled by the rectifier-type voltmeter. The indicating meter is equipped with an auxiliary decibel scale, useful in many types of measurements.

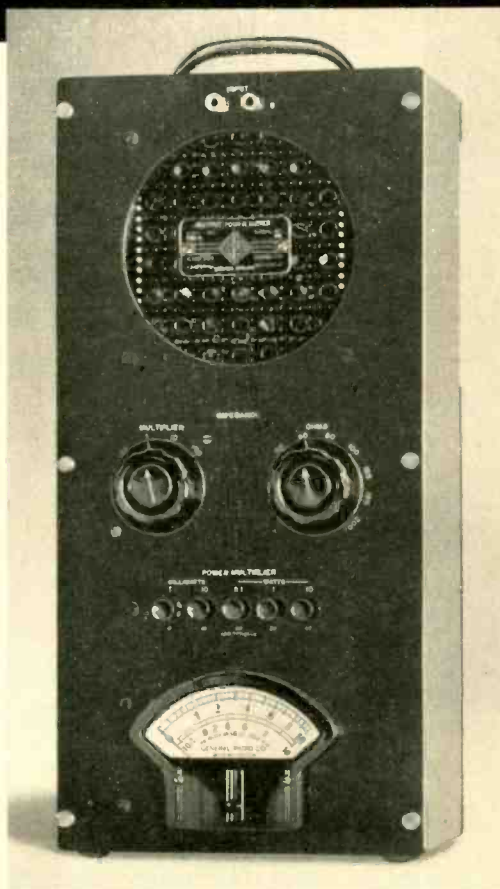

TYPE 783-A OUTPUT-POWER METER \$310.00



GENERAL RADIO COMPANY

Cambridge 39,
Massachusetts

90 West St., New York 6 920 S. Michigan Ave., Chicago 5 1000 N. Seward St., Los Angeles 38

OPERATING INSTRUCTIONS

1066



TYPE **783-A**

OUTPUT-POWER METER

GENERAL RADIO COMPANY

548-F

OPERATING INSTRUCTIONS

TYPE **783-A**

OUTPUT-POWER METER

Form 548-F
January, 1960

GENERAL RADIO COMPANY
WEST CONCORD, MASSACHUSETTS, USA

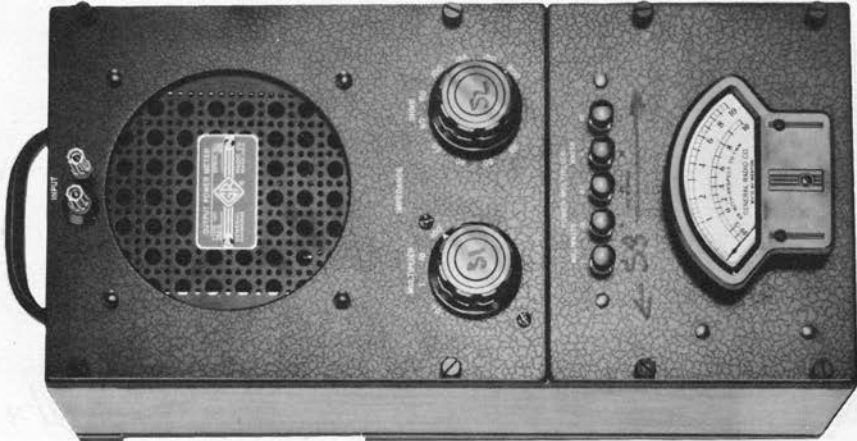

Figure 1.
Type 783-A Output-Power Meter

SPECIFICATIONS

- Power Range:** 0.2 mw to 100 w in five ranges. Auxiliary db scale on the meter reads from -10 to +10 db above 1 mw. With multiplier, total range is -10 to +50 db above 1 mw.
- Impedance Range:** 2.5 to 20,000 ohms. Forty discrete impedances, distributed approximately logarithmically, are obtained by a 10-step selector and 4-step multiplier.
- Impedance Accuracy:** $\pm 2\%$ except for high impedances at high audio frequencies (refer to Section 3).
- Power Accuracy:** ± 0.25 db at full-scale reading. At lowest impedance multiplier setting (2.5 to 20 ohms) an additional error of 0.2 db may appear due to switch contact resistance with power multiplier set at 10 (10 to 100 watt range).
Over-all frequency characteristic of power indication is flat within ± 0.5 db from 20 to 10,000 cps; within 0.75 db to 15,000 cps.
- Waveform Error:** Nonsinusoidal voltages may cause error, since meter is not a true rms indicator. With waveforms normally encountered in communications, error is not serious (refer to Section 3).
- Temperature and Humidity Effects:** Instrument calibrated at 77 F, and if ambient temperature varies widely from this value, additional errors will result. At high temperatures (95 F), this error may approach the nominal calibration error, especially at higher audio frequencies. The heat dissipated by the instrument has a negligible effect on accuracy.

- Mounting:** Walnut cabinet, with aluminum panel.
- Dimensions:** Width 8 in., length 18 in., depth 7 in., over-all.
- Weight:** 17 lb.

TYPE 783-A OUTPUT-POWER METER

1 INTRODUCTION

1.1 PURPOSE. The Type 783-A Output-Power Meter (Figure 1) gives a direct indication of the power output of audio-frequency circuits, and can be used to test amplifiers, transformers, oscillators, filters, and similar networks. Often used to simulate loud-speaker or other load impedances in high-power audio systems, the Output-Power Meter will handle power outputs up to 100 watts, yet is sensitive enough to measure directly the power output of a phonograph pickup.

1.2 DESCRIPTION.

1.2.1 GENERAL. (See Figure 2.) The Output-Power Meter is functionally an adjustable load impedance, with a voltmeter calibrated directly in watts dissipated in the load.

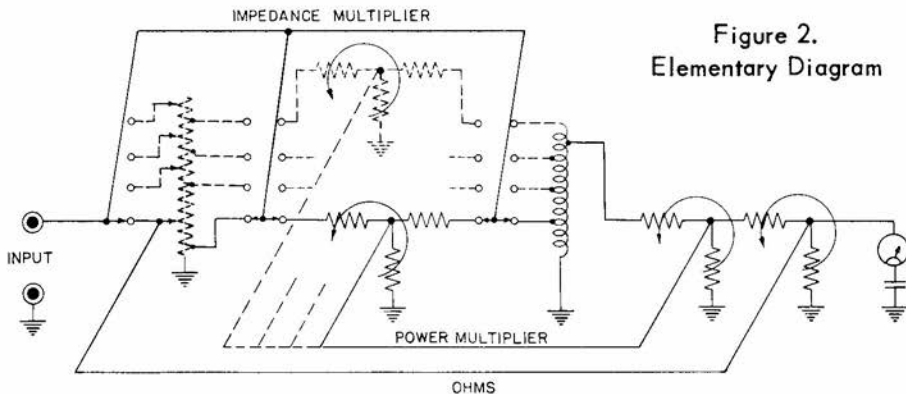

Figure 2.
Elementary Diagram

1.2.2 CONTROLS AND CONNECTIONS. The following controls and connections are on the front panel of the instrument:

<u>Name</u>	<u>Type</u>	<u>Function</u>
INPUT	Jack-top binding posts (2)	Output from circuit under test should be connected here. Right-hand post is ground.

GENERAL RADIO COMPANY

1.2.2 CONTROLS AND CONNECTIONS. (Continued)

<u>Name</u>	<u>Type</u>	<u>Function</u>
IMPEDANCE OHMS	10-position selector switch	Product of these settings equals load impedance. Forty steps, from 2.5 to 20,000 ohms, are available.
MULTIPLIER	4-position selector switch	
POWER MULTIPLIER	Pushbuttons (5)	Product of POWER MULTI- PLIER setting and meter reading (upper scale) equals measured output power. Range is from 0.2 milliwatt to 100 watts.

2 OPERATION. To measure the power that a circuit can deliver into a given impedance, simply connect the circuit output terminals to the Output-Power Meter INPUT terminals, set the load impedance to the desired value, and determine the power output from the meter indication and the POWER MULTIPLIER setting.

The Output-Power Meter can also measure the internal impedance of the circuit under test, since that impedance equals the impedance into which maximum power is delivered.

To determine the loss in a transformer working from a given source, measure the maximum output from the source, then insert the transformer between the source and the Output-Power Meter and measure the maximum output from the transformer. The difference in the two readings on the db (lower) scale equals the loss in the transformer.

3 ACCURACY OF MEASUREMENT

3.1 GENERAL. The input impedance is accurate to $\pm 2\%$. The full-scale indicated power is accurate to ± 0.25 db. When the IMPEDANCE MULTIPLIER switch is at 0.1 there may be an additional error of 0.2 db due to switch contact resistance when the POWER MULTIPLIER is at 10 watts.

The Output-Power Meter is not intended to be a precision instrument, and the uses for which it is designed usually do not justify precision methods. It combines convenience and wide range with a reasonable degree of accuracy, and permits high accuracy over a somewhat smaller range.

3.2 FREQUENCY ERRORS. At high impedances and high frequency, there is an input-impedance error, which at 15,000 cycles is about 5 percent for impedances from 10,000 to 20,000 ohms.

Power indication is essentially independent of frequency (± 0.5 db to 10,000 cycles; ± 0.75 db to 15,000 cycles).

TYPE 783-A OUTPUT-POWER METER

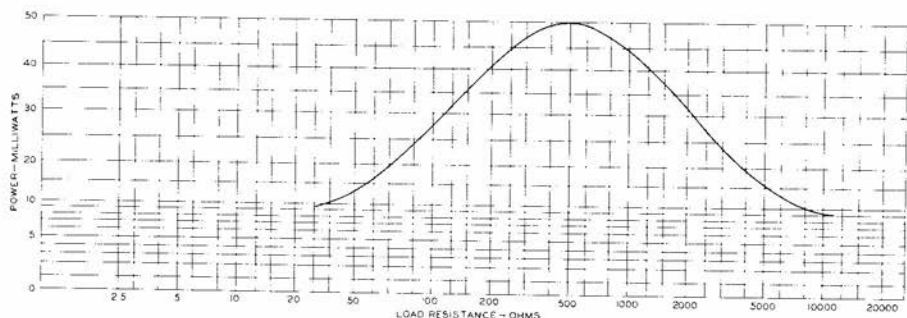

Figure 3. Power Output vs Load Resistance for a Generator with 500-ohm Internal Impedance.

Figure 3 shows power output plotted against load resistance for a generator with an internal impedance of 500 ohms. An analysis of the accuracy figures with reference to this curve shows that errors are negligible over most of the frequency range.

3.3 WAVEFORM ERRORS. The copper-oxide rectifier-type meter used in the instrument is calibrated in rms values for sinusoidal applied voltages, and nonsinusoidal voltages may cause errors, since the meter is not a true rms instrument. The degree of error depends on the magnitude and phase of the harmonics present, and will be small with waveforms normally encountered in communications.

3.4 REACTANCE ERRORS. The Output-Power Meter is designed to work out of a resistive impedance, and will be subject to error when used in measurements on a highly reactive source. Unless the reactance is large enough to affect materially the power factor of the internal impedance of the circuit under test, this error is negligible.

3.5 DIRECT-CURRENT ERROR. The error in indicated power because of a d-c component from the power source is usually negligible even under the least favorable circumstances. At a 60-cycle power-source frequency, a 0.5-amp d-c component will introduce an error of less than 0.2 db in indicated power reading.

3.6 TEMPERATURE AND HUMIDITY EFFECTS: The Output-Power Meter was calibrated at a temperature of 77 degrees Fahrenheit, and errors in indication will result if the ambient temperature departs widely from this value. At high temperatures (about 95 degrees F) this additional error may approach the nominal calibration error, especially at the higher audio frequencies. The instrument is so designed that the heat dissipated inside the instrument itself has a negligible effect on accuracy. Humidity conditions also have a negligible effect on the accuracy of the instrument.

GENERAL RADIO COMPANY

PARTS LIST

	REF DES			GR NO.		REF DES			GR NO.	
RESISTORS (NOTE A)	R1	5.242	±2%	783-301	RESISTORS (NOTE A)	R39	2500	±2%	783-315	
	R2	5.242	±2%	783-301		R40	2500	±2%		
	R3	0.557	±2%	783-302		R41	5000	±2%		
	R4	1.152	±2%			R42	49,450	±1%	Part of 783-316	
	R5	1.210	±2%			783-303	R43	5446	±¼%	783-320
	R6	1.278	±2%				R44	560	±¼%	
	R7	2.000	±2%	R45			1292	±½%		
	R8	2.000	±2%	783-304		R46	4945	±1%	Part of 783-316	
	R9	2.500	±2%			783-305	R47	544.6	±¼%	783-321
	R10	2.500	±2%				R48	56.0	±¼%	
	R11	5.000	±2%	R49			129.2	±¼%		
	R12	5.392	±2%	783-306		R50	494.5	±1%	Part of 783-317	
	R13	5.570	±2%			783-307	R51	54.46	±¼%	783-322
	R14	11.52	±2%				R52	5.60	±½%	
	R15	12.10	±2%	R53			12.92	±½%		
	R16	12.78	±2%	783-308		R54	49.45	±1%	Part of 783-317	
	R17	20.00	±2%			783-309	R55	5.44	±½%	Part of 783-326
	R18	20.00	±2%				R56	0.558	±½%	
	R19	25.00	±2%	R57			1.284	±½%		
	R20	25.00	±2%	783-311		R58	11,700	±½%	REPR-16	
	R21	50.00	±2%			783-312	R59	1444.4	±¼%	Part of 783-326
	R22	53.92	±2%				R60	8889	±½%	REPR-16
	R23	57.70	±2%	R61			6012	±½%	REPR-16	
	R24	115.2	±2%	783-313		R62	1741	±¼%	Part of 783-318	
	R25	121.0	±2%			R63	982.5	±¼%		
	R26	127.8	±2%			R64	1083.5	±¼%		
	R27	200.0	±2%	783-314		R65	971	±¼%	783-319	
	R28	200.0	±2%			R66	1101	±¼%		
	R29	250.0	±2%			R67	221	±¼%		
	R30	250.0	±2%	783-316		R68	46.0	±1%	Part of 783-318	
	R31	500.0	±2%			R69	1155	±¼%		
	R32	539.2	±2%			R70	1042	±¼%		
	R33	557.0	±2%	783-317		R71	20,000	±5%	REC-20BF	
	R34	1152	±2%							
	R35	1210	±2%							
	R36	1278	±2%							
	R37	2000	±2%							
	R38	2000	±2%							

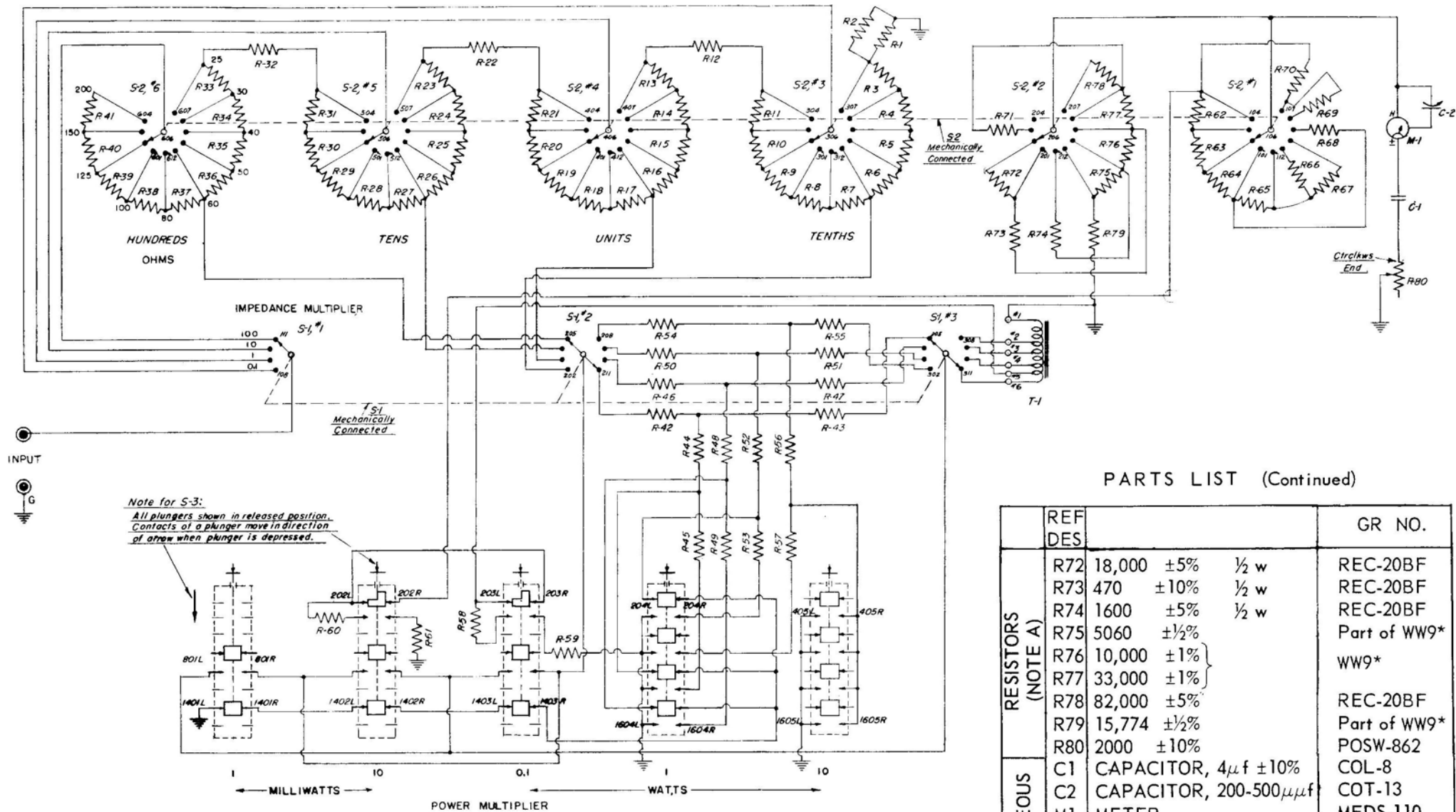

PARTS LIST (Continued)

	REF DES		GR NO.
RESISTORS (NOTE A)	R72	18,000 ±5%	REC-20BF
	R73	470 ±10%	REC-20BF
	R74	1600 ±5%	REC-20BF
	R75	5060 ±½%	Part of WW9*
	R76	10,000 ±1%	WW9*
	R77	33,000 ±1%	
	R78	82,000 ±5%	REC-20BF
	R79	15,774 ±½%	Part of WW9*
	R80	2000 ±10%	POSW-862
MISCELLANEOUS	C1	CAPACITOR, 4μf ±10%	COL-8
	C2	CAPACITOR, 200-500μμf	COT-13
	M1	METER	MEDS-110
	S1	SWITCH	783-32
	S2	SWITCH	783-34
	S3	SWITCH	783-323-2
T1	TRANSFORMER	485-418	

NOTES: (A) All resistances are in ohms.
 * IRC Part No.

GENERAL RADIO COMPANY

WEST CONCORD, MASSACHUSETTS

EMerson 9-4400

CLearwater 9-8900

DISTRICT OFFICES

NEW YORK

Broad Ave. at Linden, Ridgefield, N. J.
Telephone N.Y. WOrth 4-2722
N.J. WHitney 3-3140

PHILADELPHIA

1150 York Rd., Abington, Penna.
Telephone HANcock 4-7419

WASHINGTON

8055 13th St., Silver Spring, Md.
Telephone JUNiper 5-1088

CHICAGO

6605 West North Ave., Oak Park, Ill.
Telephone Village 8-9400

LOS ANGELES

1000 N. Seward St., Los Angeles 38,
Calif.
Telephone HOLLYwood 9-6201

SAN FRANCISCO

1186 Los Altos Ave., Los Altos, Calif.
Telephone WHIteliff 8-8233

CANADA

99 Floral Pkwy., Toronto 15, Ont.
Telephone CHerry 6-2171

REPAIR SERVICES

EAST COAST

General Radio Company
Service Department
22 Baker Ave., W. Concord, Mass.
Telephone EMerson 9-4400

NEW YORK

General Radio Company
Service Department
Broad Ave. at Linden, Ridgefield, N. J.
Telephone N.Y. WOrth 4-2722
N.J. WHitney 3-3140

MIDWEST

General Radio Company
Service Department
6605 West North Ave., Oak Park, Ill.
Telephone Village 8-9400

WEST COAST

General Radio Company
Service Department
1000 N. Seward St., Los Angeles 38, Calif.
Telephone HOLLYwood 9-6201

CANADA

Bayly Engineering, Ltd.
First Street, Ajax, Ontario
Telephone Toronto EMpire 2-3741